

fluimac[®]
pump solution

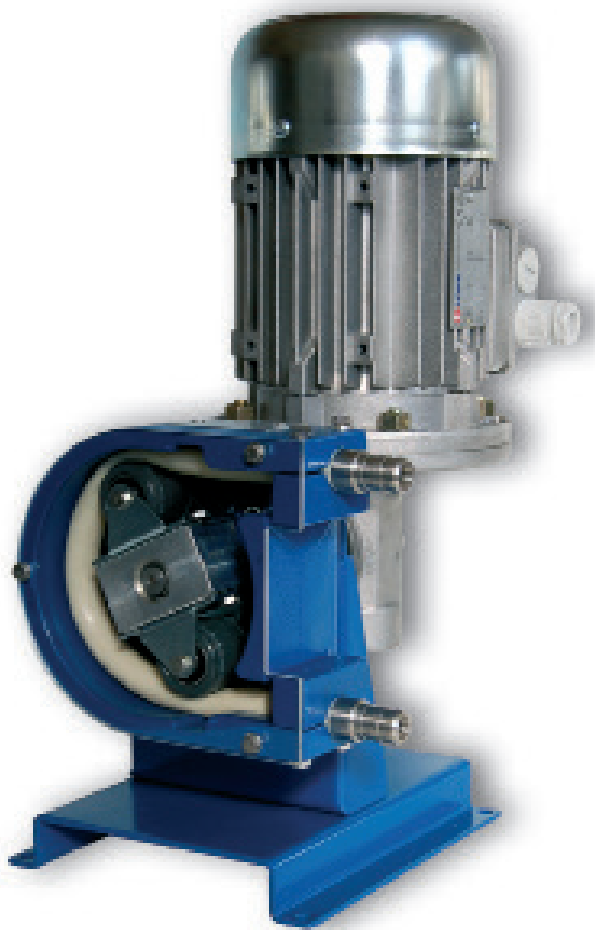

HELIOS
POMPE PERISTALTICHE

Made in
Italy

www.fluimac.com

ITALIANO 



HELIOS AS

Pompe peristaltiche dosatrici - Bassa Pressione
Portata max 2800 l/h - Prevalenza max 4 bar
Viscosità fino a 1500 cps - Aspirazione fino a 6 m

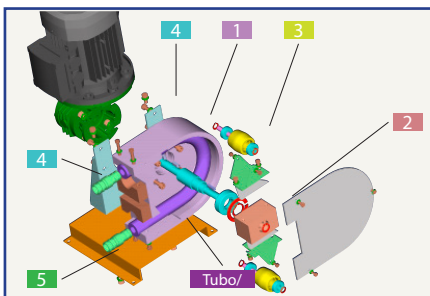

Elemento	Material
1 Corpo Pompa	Lega Di Alluminio
2 Rotore	Lega Di Alluminio
3 Rulli	PVC
As 25	Lega Di Alluminio
4 Basamento	Ferro
5 Portagomma	AISI 304

Abbinamenti speciali:

Portagomma in aisi 316, PVC, PTFE
 DIN
 TRI-CLAMP
 FLANGE ANSI, ISO, UNI

CARATTERISTICHE TECNICHE

- Dosaggio costante, misurato e preciso
- Lunga vita operativa e grande affidabilità
- Autoadescante
- Aspirazione continua a secco
- Bassi costi di gestione
- Manutenzione facile e veloce

MATERIALI PER TUBO:

- NR
- NBR
- Norprene®
- Silicone
- EPDM
- Pharmed®
- Tygon (AS25)
- Hypalon (AS25)



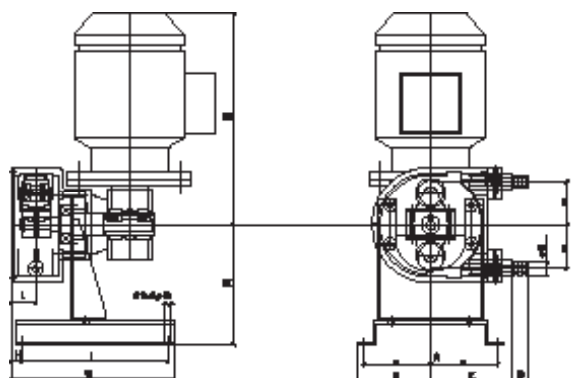

DIMENSIONI DI INGOMBRO

MODELLO	A	B	C	D	E	F	G	H	I	L	M	N	øO	Kg.
AS 10 FX	172	92	92	20	15	104	185	12	166	28	137	245	7	9
AS 15 FX	172	92	110	20	20	127	183	12	166	30	137	245	7	10
AS 20 FX	210	112	142	35	25	175	248	18	220	40	184	260	7	18
AS 25 FX	250	146	210	45	32	254	386	81	290	52	228	370	11	40

DATI TECNICI

MODELLO	Q (L/H)	A	P	RPM	I	KW	di	Qu	Nm
AS 10 FX	23	4	15	23	60	0,18	9	0,017	6
	35	4	15	35	40	0,18			
	47	4	15	47	30	0,18			
	70	4	15	70	20	0,18			
	93	4	15	93	15	0,18			
AS 15 FX	56	4	15	23	60	0,18	13	0,041	12
	86	4	15	35	40	0,18			
	115	4	15	47	30	0,18			
	172	4	15	70	20	0,18			
	228	4	15	93	15	0,18			
AS 20 FX	149	5	* 15 - 40	23	60	0,18	17	0,108	20
	227	5	* 15 - 40	35	40	0,18			
	305	5	* 15 - 30	47	30	0,18			
	453	5	* 15 - 30	70	20	0,18			
	602	5	* 10 - 20	93	15	0,18			
AS 25 FX	538	6	* 20 - 40	28	60	0,37	25	0,320	30
	672	6	* 20 - 40	35	40	0,37			
	902	6	* 20 - 30	47	30	0,37			
	1344	6	* 20 - 30	70	20	0,75			
	1785	6	* 15 - 25	93	15	0,75			

MOTORE 3 PH- VOLTS 230/400 HZ 50 R.P.M. I400 IP55

*= Dipende dal materiale del tubo

A = Capacità di aspirazione in metri
 P = Prevalenza in metri
 I = Rapporto riduttore

di = Diametro interno tubo
 Qu = Litri per giro
 Nm = Coppia minima di spunto



DISPONIBILE CON CERTIFICAZIONE ATEX:
 EX: I M2 & II 2G & IIB, TX

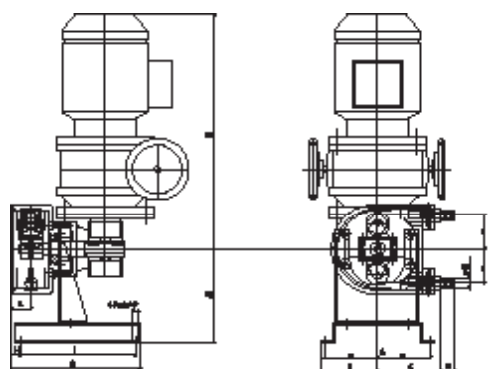

DIMENSIONI DI INGOMBRO

MODELLO	A	B	C	D	E	F	G	H	I	L	M	N	øO	Kg.
AS 10 VX	172	92	92	20	15	104	185	12	166	28	137	328	7	12
AS 15 VX	172	92	110	20	20	127	183	12	166	30	137	328	7	13
AS 20 VX	210	112	142	35	25	175	248	18	220	40	184	343	7	22
AS 25 VX	250	146	210	45	32	254	386	81	290	52	228	476	11	45

DATI TECNICI

MODELLO	Q (L/H)	A	P	RPM	I	KW	di	Qu	Nm
AS 10 VX	3,2 ÷ 15	4	15	3,2 ÷ 15	60	0,22			
	4,7 ÷ 22,5	4	15	4,7 ÷ 22,5	40	0,22			
	6,3 ÷ 30	4	15	6,3 ÷ 30	30	0,22	9	0,017	6
	9,5 ÷ 45	4	15	9,5 ÷ 45	20	0,22			
	19 ÷ 90	4	15	19 ÷ 90	10	0,22			
AS 15 VX	7,8 ÷ 37	4	15	3,2 ÷ 15	60	0,22			
	11,6 ÷ 55	4	15	4,7 ÷ 22,5	40	0,22			
	15,5 ÷ 73,8	4	15	6,3 ÷ 30	30	0,22	13	0,041	12
	23,4 ÷ 110	4	15	9,5 ÷ 45	20	0,22			
	47 ÷ 221	4	15	19 ÷ 90	10	0,22			
AS 20 VX	21 ÷ 97	5	* 15 - 40	3,2 ÷ 15	60	0,22			
	30 ÷ 146	5	* 15 - 40	4,7 ÷ 22,5	40	0,22			
	41 ÷ 194	5	* 15 - 40	6,3 ÷ 30	30	0,22	17	0,108	20
	62 ÷ 291	5	* 15 - 40	9,5 ÷ 45	20	0,22			
	82 ÷ 388	5	* 15 - 40	12,7 ÷ 60	15	0,22			
AS 25 VX	73 ÷ 365	6	* 20 - 40	3,8 ÷ 19	60	0,37			
	90 ÷ 455	6	* 20 - 40	4,7 ÷ 23,7	40	0,37			
	121 ÷ 608	6	* 20 - 35	6,3 ÷ 31,7	30	0,37	25	0,320	30
	182 ÷ 912	6	* 15 - 30	9,5 ÷ 47,5	20	0,37			
	243 ÷ 1280	6	* 15 - 25	12,7 ÷ 66,7	15	0,75			

MOTORE 3 PH- VOLTS 230/400 HZ 50 R.P.M. I400 IP55

*= Dipende dal materiale del tubo

A = Capacità di aspirazione in metri

P = Prevalenza in metri

I = Rapporto riduttore

di = Diametro interno tubo

Qu = Litri per giro

Nm = Coppia minima di spunto

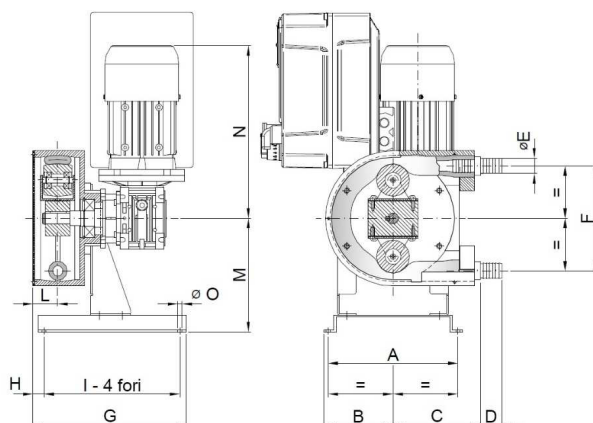

DIMENSIONI DI INGOMBRO

MODELLO	A	B	C	D	E	F	G	H	I	L	M	N	øO	Kg.
AS 10 IX	172	92	92	20	15	104	185	12	166	28	137	245	7	9
AS 15 IX	172	92	110	20	20	127	183	12	166	30	137	245	7	10
AS 20 IX	210	112	142	35	25	175	248	18	220	40	184	260	7	18
AS 25 IX	250	146	210	45	32	254	386	81	290	52	228	370	11	40

DATI TECNICI

MODELLO	Q (L/H)	A	P	RPM	I	KW	di	Qu	Nm
AS 10 IX	1,5 ÷ 47	4	15	1,5 ÷ 47	60	0,18	9	0,017	6
	3 ÷ 93	4	15	3 ÷ 93	30	0,18			
	6 ÷ 185	4	10	6 ÷ 185	15	0,18			
AS 15 IX	3,7 ÷ 115	4	15	1,5 ÷ 47	60	0,18	13	0,041	12
	7 ÷ 172	4	15	2,8 ÷ 70	40	0,18			
	15 ÷ 345	4	15	6 ÷ 140	30	0,18			
AS 20 IX	10 ÷ 304	5	* 15 - 40	1,5 ÷ 47	60	0,18	17	0,108	20
	18 ÷ 453	5	* 15 - 40	2,8 ÷ 70	40	0,18			
	20 ÷ 602	5	* 15 - 30	3 ÷ 93	30	0,18			
AS 25 IX	29 ÷ 902	6	* 20 - 40	1,5 ÷ 47	60	0,37	25	0,320	30
	54 ÷ 1344	6	* 20 - 40	2,8 ÷ 70	40	0,55			
	58 ÷ 1785	6	* 15 - 25	3 ÷ 93	30	0,75			

MOTORE 3 PH- VOLTS 230/400 HZ 50 R.P.M. 1400 IP55

*= Dipende dal materiale del tubo

SEGNALE 4-20mA SU RICHIESTA

A = Capacità di aspirazione in metri
 P = Prevalenza in metri
 I = Rapporto riduttore

di = Diametro interno tubo
 Qu = Litri per giro
 Nm = Coppia minima di spunto

CURVE DI PERFORMANCE

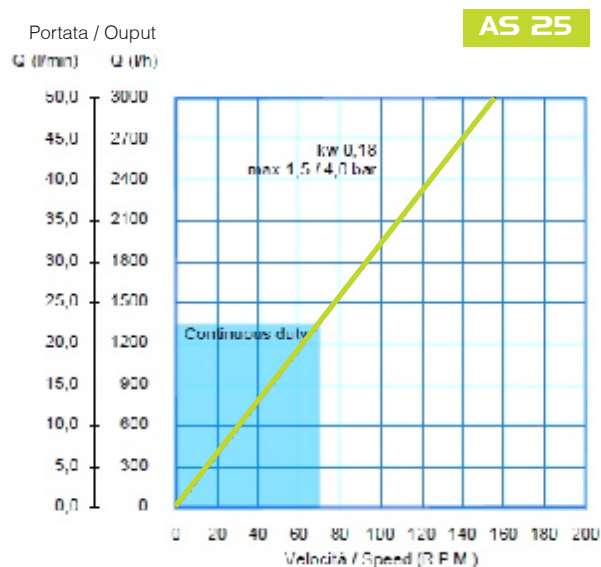
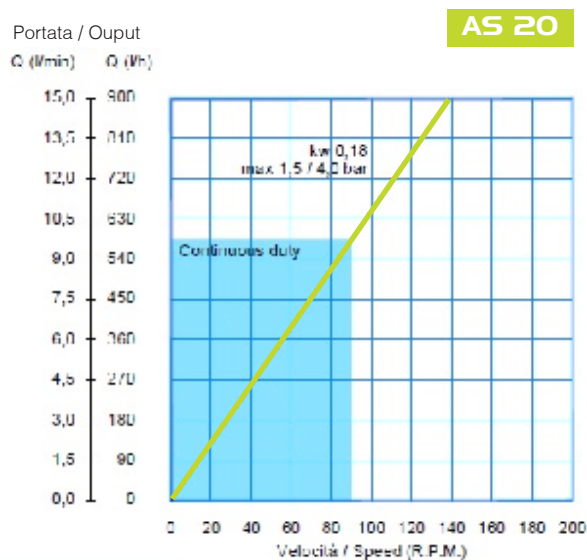
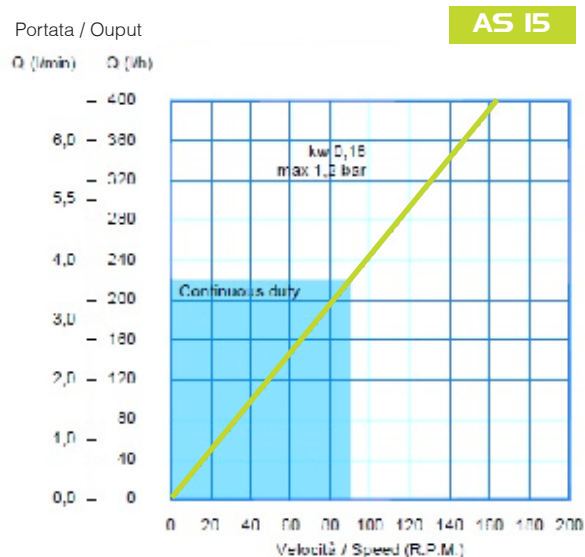
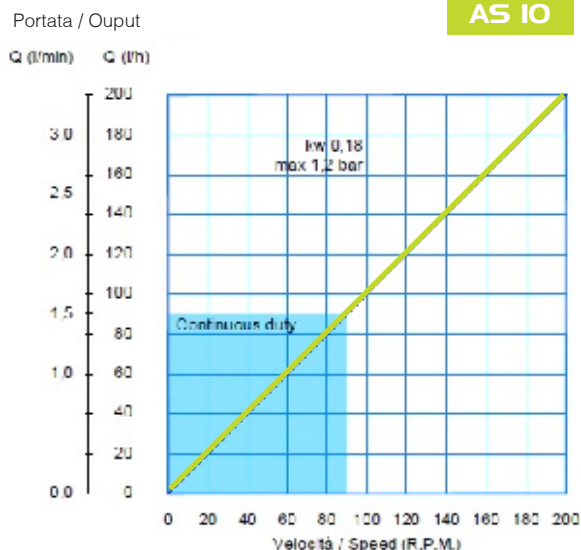

VERSIONI SPECIALI



A DOPPIA TESTA
POMPANTE

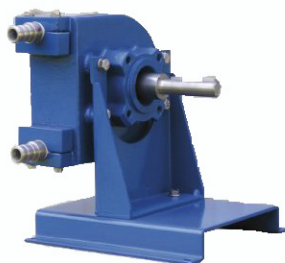

TESTA
POMPANTE

COME UTILIZZARE LE CURVE

- La portata richiesta indica la velocità della pompa
- Prevalenza calcolata
- Velocità netta richiesta della potenza del motore
- Temperatura del fluido
- Velocità massima della pompa consigliata

I dati tecnici sopra indicati si riferiscono a fluidi come l'acqua e simili



HELIOS ASP

Pompe peristaltiche
Portata max 25000 l/h - prevalenza max 10 bar
Viscosità fino a 60000 cps - aspirazione fino a 8 m

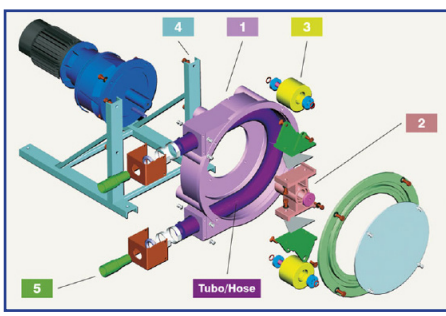

Elemento

- 1 Corpo Pompa
- 2 Rotore
- 3 Rulli
- 4 Basamento
- 5 Portagomma

Materiale

- Lega Di Alluminio
- Lega Di Alluminio
- Nylatron Di Alluminio
- Ferro
- AISI 304

Abbinamenti speciali:

- Portagomma in AISI 316, PVC, PTFE
- DIN
- TRI-CLAMP
- FLANGE ANSI, ISO, UNI

CARATTERISTICHE TECNICHE

- Nessuna tenuta meccanica
- Robusta
- Adatta per fluidi viscosi e aggressivi
- Aspirazione a secco continua e priva di danni
- Pressione di uscita fino a 10 bar
- Manutenzione semplice

MATERIALI PER TUBO:

- NR
- NBR
- EPDM
- NBR Food
- NR Food
- Hypalon
- EPDM Food

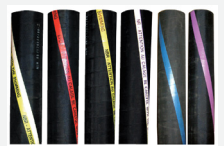

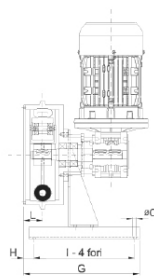

ASP 10/15

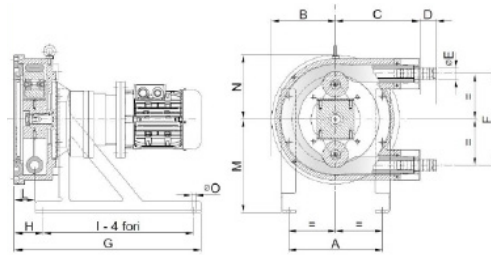
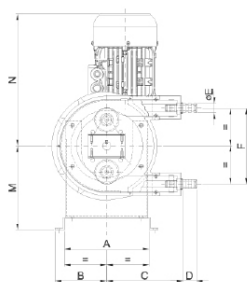

ASP 25/15 - 25 - 32 - 40 - 50 - 65

DIMENSIONI DI INGOMBRO

MODELLO	A	B	C	D	E	F	G	H	I	L	M	N	øO	Kg.
ASP 10 FX	210	112	166	25	15	167	251	21	220	40	184	260	7	16
ASP 15 FX	210	112	166	30	20	167	251	21	220	40	184	260	7	16
ASP 25/15 FX	250	170	224	25	20	240	495	75	400	52	228	70	11	44
ASP 25 FX	250	170	224	25	32	240	495	75	400	52	228	170	11	44
ASP 32 FX	330	217	230	66	40	314	655	114	520	68	300	217	11	80
ASP 40 FX	420	270	340	70	50	398	735	130	580	74	370	270	14	120
ASP 50 FX	420	330	380	80	65	512	833	158	650	88	440	330	14	160
ASP 65 FX	566	440	510	91	80	672	1107	142	930	106	570	440	17	430

DATI TECNICI

MODELLO	Q (L/H)	A	P	RPM	I	KW	di	Qu	Nm
ASP 10 FX	47	8	100	23	60	0,18	10	0,034	35
	72	8	80	35	40	0,18			
	96	8	80	47	30	0,37			
	143	8	80	70	20	0,37			
ASP 15 FX	102	8	100	23	60	0,18	15	0,074	35
	155	8	80	35	40	0,18			
	209	8	80	47	30	0,37			
	310	8	80	70	20	0,37			
ASP 25/15 FX	275	8	80	35	40	0,55	15	0,131	40
	354	8	80	45	31,5	0,75			
	440	8	70	56	25	0,75			
	550	8	60	70	20	0,75			
ASP 25 FX	672	8	80	35	40	0,55	25	0,32	40
	864	8	80	45	31,5	0,75			
	1075	8	70	56	25	0,75			
	1344	8	60	70	20	0,75			
ASP 32 FX	1596	8	100	38	37	1,1	32	0,70	75
	1974	8	80	47	30	1,1			
	2436	8	60	58	24	1,1			
	2940	8	40	70	20	1,1			
ASP 40 FX	2040	8	100	25	56	1,5	40	1,36	110
	2938	8	80	36	39	1,5			
	3672	8	60	45	31,5	1,5			
	5712	8	40	70	20	1,5			
ASP 50 FX	4185	8	100	25	56	2,2	50	2,79	200
	6026	8	60	36	39	2,2			
	7533	8	60	45	31,5	3			
	11718	8	40	70	20	3			
ASP 65 FX	8580	8	80	22	63	4	65	6,50	400
	13650	8	60	35	40	5,5			
	15500	8	60	45	31,5	7,5			
	21840	8	50	56	25	7,5			

MOTORE 3 PH- VOLTS 230/400 HZ 50 R.P.M. I400 IP55

A = Capacità di aspirazione in metri

P = Prevalenza in metri

I = Rapporto riduttore

* = Dipende dal materiale del tubo

di = Diametro interno tubo

Qu = Litri per giro

Nm = Coppia minima di spunto



DISPONIBILE CON CERTIFICAZIONE ATEX:

EX: I M2 & II 2G & IIB, TX

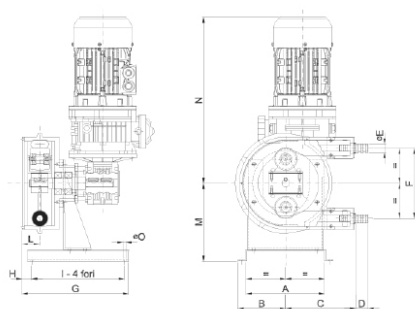

ASP 10/15

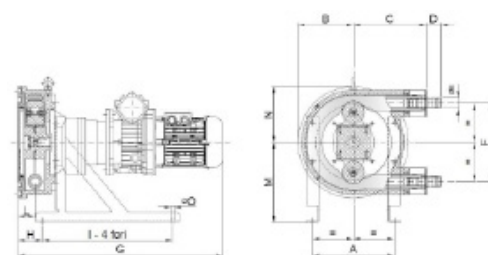

ASP 25/15 - 25 - 32 - 40 - 50 - 65

DIMENSIONI DI INGOMBRO

MODELLO	A	B	C	D	E	F	G	H	I	L	M	N	øO	Kg.
ASP 10 VX	210	112	166	25	15	167	251	21	220	40	184	345	7	20
ASP 15 VX	210	112	166	30	20	167	251	21	220	40	184	345	7	20
ASP 25/15 VX	250	170	224	45	20	240	640	75	400	52	228	170	11	50
ASP 25 VX	250	170	224	45	32	240	640	75	400	52	228	170	11	50
ASP 32 VX	330	217	290	66	40	314	735	114	520	68	300	217	11	90
ASP 40 VX	420	270	340	70	50	398	884	130	580	74	370	270	14	120
ASP 50 VX	420	330	380	80	65	512	1017	158	650	88	440	330	14	180
ASP 65 VX	566	440	510	91	80	672	1385	142	930	106	570	440	18	430

DATI TECNICI

MODELLO	Q (L/H)	A	P	RPM	I	KW	di	Qu	Nm
ASP 10 VX	6,5÷30,6	8	100/80	3,2÷15	60	0,22	10	0,034	35
	9,6÷46	8	100/70	4,7÷22,5	40	0,22			
	15,5÷77,5	8	100/60	7,6÷38	25	0,37			
	26÷129	8	100/50	12,7÷63,3	15	0,37			
ASP 15 VX	14,2÷66,6	8	100/80	3,2÷15	60	0,22	15	0,074	35
	21÷100	8	100/70	4,7÷22,5	40	0,22			
	34÷168,7	8	100/60	7,6÷38	25	0,37			
	56,4÷281	8	100/50	12,7÷63,3	15	0,37			
ASP 25/15 VX	37÷196,5	8	100/60	4,7÷25	40	0,55	15	0,131	40
	60÷314,4	8	100/70	7,6÷40	25	0,75			
	94,3÷487,3	8	100/50	12÷62	16	0,75			
	118÷629	8	100/40	15÷80	12,5	0,75			
ASP 25 VX	90÷480	8	100/60	4,7÷25	40	0,55	25	0,32	40
	146÷768	8	100/60	7,6÷40	25	0,75			
	230÷1190	8	100/50	12÷62	16	0,75			
	288÷1536	8	100/40	15÷80	12,5	0,75			
ASP 32 VX	210÷1134	8	100/60	5÷27	37	1,1	32	0,70	75
	319÷1680	8	100/60	7,6÷40	25	1,1			
	504÷2604	8	100/50	12÷62	16	1,1			
	630÷3360	8	100/40	15÷80	12,5	1,1			
ASP 40 VX	342÷1811	8	100/60	4,2÷22,2	45	1,5	40	1,36	110
	489÷2611	8	100/60	6÷32	31,5	1,5			
	775÷4080	8	100/50	9,5÷50	20	2,2			
	979÷5059	8	100/40	12÷62	16	2,2			
ASP 50 VX	703÷3716	8	100/60	4,2÷22,2	45	2,2	50	2,79	200
	1004÷5356	8	100/60	6÷32	31,5	2,2			
	1590÷8370	8	100/50	9,5÷50	20	3			
	2008÷10378	8	100/40	12÷62	16	3			
ASP 65 VX	1638÷8658	8	100/60	4,2÷22,2	45	4	65	6,50	400
	2340÷12480	8	100/60	6÷32	31,5	5,5			
	2964÷15600	8	100/50	7,6÷40	25	7,5			
	3705÷19500	8	100/40	9,5÷50	20	7,5			

MOTORE 3 PH- VOLTS 230/400 HZ 50 R.P.M. 1400 IP55

*= Dipende dal materiale del tubo

A = Capacità di aspirazione in metri

di = Diametro interno tubo

P = Prevalenza in metri

Qu = Litri per giro

I = Rapporto riduttore

Nm = Coppia minima di spunto



DISPONIBILE CON CERTIFICAZIONE ATEX:
EX: I M2 & II 2G & IIB, TX

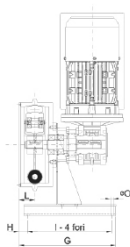
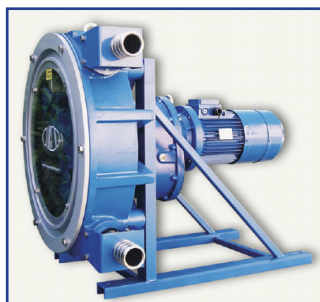

ASP 10/15

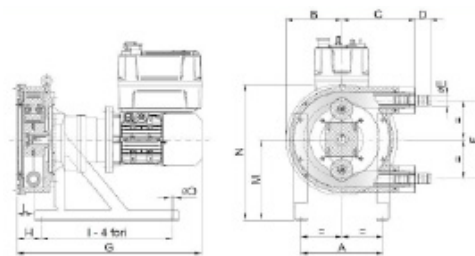
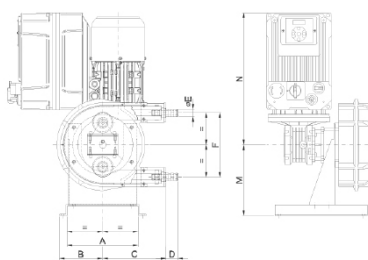

ASP 25/15 - 25 - 32 - 40 - 50 - 65

DIMENSIONI DI INGOMBRO

MODELLO	A	B	C	D	E	F	G	H	I	L	M	N	øO	Kg.
ASP 10 IX	210	112	166	25	15	167	251	21	220	40	184	334	7	25
ASP 15 IX	210	112	166	30	20	167	251	21	220	40	184	334	7	25
ASP 25/15 IX	250	170	224	25	20	240	550	75	400	52	228	398	11	54
ASP 25 IX	250	170	224	25	32	240	550	75	400	52	228	398	11	54
ASP 32 IX	330	217	230	66	40	314	654	114	520	68	300	517	11	90
ASP 40 IX	420	270	340	70	50	398	735	130	580	74	370	640	14	130
ASP 50 IX	420	330	380	80	65	512	833	158	650	88	440	770	14	170
ASP 65 IX	566	440	510	91	80	672	1107	142	930	106	570	1010	18	430

DATI TECNICI

MODELLO	Q (L/H)	A	P	RPM	I	KW	di	Qu	Nm
ASP 10 IX	9÷65	8	100/80	4,5÷32	60	0,25	10	0,034	35
	19÷130	8	100/60	9,3÷65	40	0,37			
	28,5÷200	8	100/50	14÷98	20	0,37			
ASP 15 IX	20÷142	8	100/80	4,5÷32	60	0,25	15	0,074	35
	41,3÷289	8	100/60	9,3÷65	30	0,37			
	62÷435	8	100/50	14÷98	20	0,37			
ASP 25/15 IX	55÷385	8	100/80	7÷49	40	0,75	15	0,131	40
	71÷495	8	100/60	9÷63	31,5	0,75			
	110÷870	8	100/50	14÷98	20	0,75			
ASP 25 IX	134÷940	8	100/80	7÷49	40	0,75	25	0,32	40
	173÷1210	8	100/60	9÷63	31,5	0,75			
	268÷1880	8	100/50	14÷98	20	0,75			
ASP 32 IX	294÷2058	8	100/80	7÷42	46	1,5	32	0,70	75
	390÷2730	8	100/50	9,3÷65	30	1,5			
	588÷4116	8	100/40	14÷98	20	1,5			
ASP 40 IX	408÷2856	8	100/80	5÷35	56	1,5	40	1,36	110
	734÷5140	8	100/50	9÷63	31,5	2,2			
	938÷6528	8	100/40	11,5÷80	24,5	2,2			
ASP 50 IX	837÷5860	8	100/80	5÷35	56	2,2	50	2,79	200
	1507 ÷ 10546	8	100/50	9÷63	31,5	3			
	1925÷13395	8	100/40	11,5÷80	24,5	4			
ASP 65 IX	1720÷12090	8	100/80	4,4÷31	63	7,5	65	6,50	400
	2730÷19110	8	100/50	7÷49	40	7,5			
	3510÷24570	8	100/40	9÷63	31,5	7,5			

MOTORE 3 PH- VOLTS 230/400 HZ 50 R.P.M. 1400 IP55

*= Dipende dal materiale del tubo

SEGNALE 4-20mA SU RICHIESTA

A = Capacità di aspirazione in metri
 P = Prevalenza in metri
 I = Rapporto riduttore

di = Diametro interno tubo
 Qu = Litri per giro
 Nm = Coppia minima di spunto

CURVE DI PERFORMANCE

ASP 10

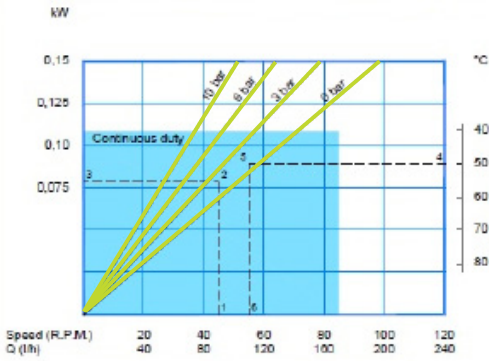

ASP 15

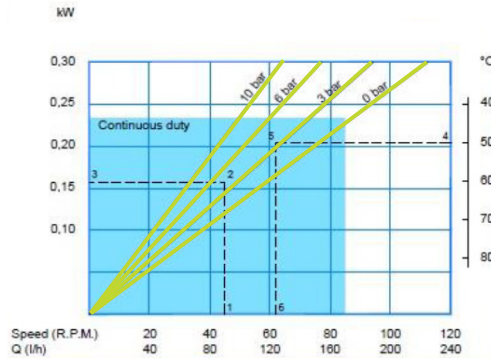

ASP 25/15

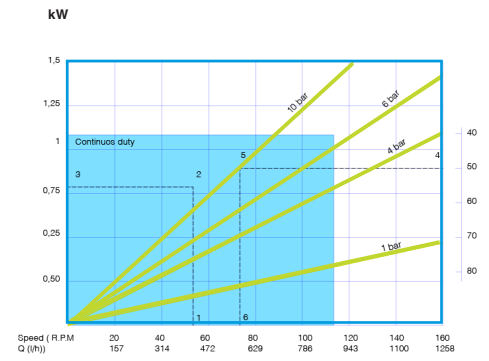

ASP 25

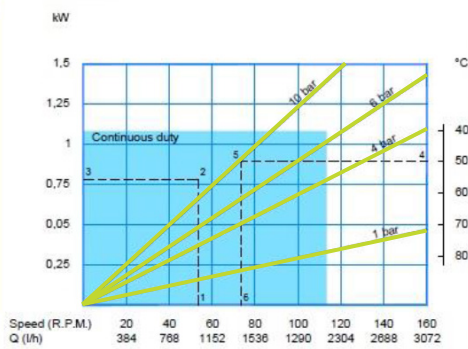

ASP 32

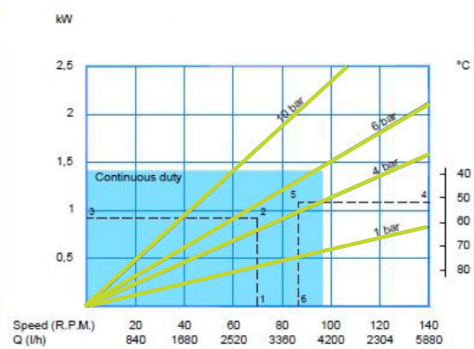

ASP 40

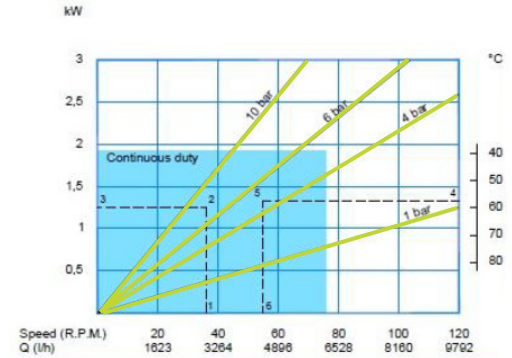

ASP 50

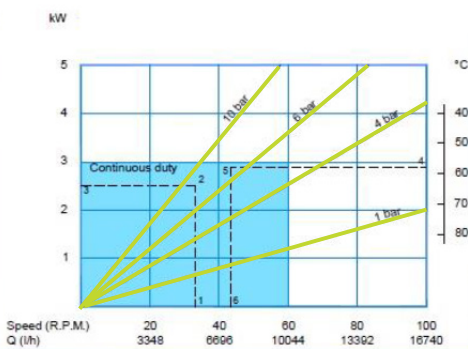

ASP 65

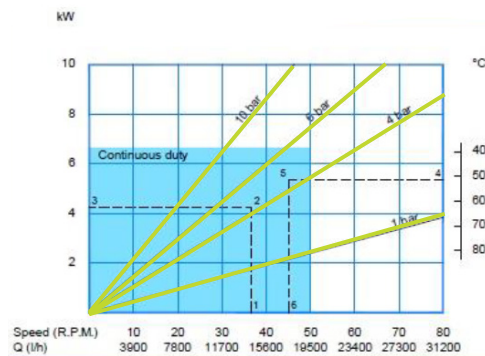

COME UTILIZZARE LE CURVE

- La portata richiesta indica la velocità della pompa
- Prevalenza calcolata
- Velocità netta richiesta della potenza del motore
- Temperatura del fluido
- Velocità massima della pompa consigliata

I dati tecnici sopra indicati si riferiscono a fluidi come l'acqua e simili

VERSIONI SPECIALI



A DOPPIA TESTA
POMPANTE



TESTA
POMPANTE



TROLLEY

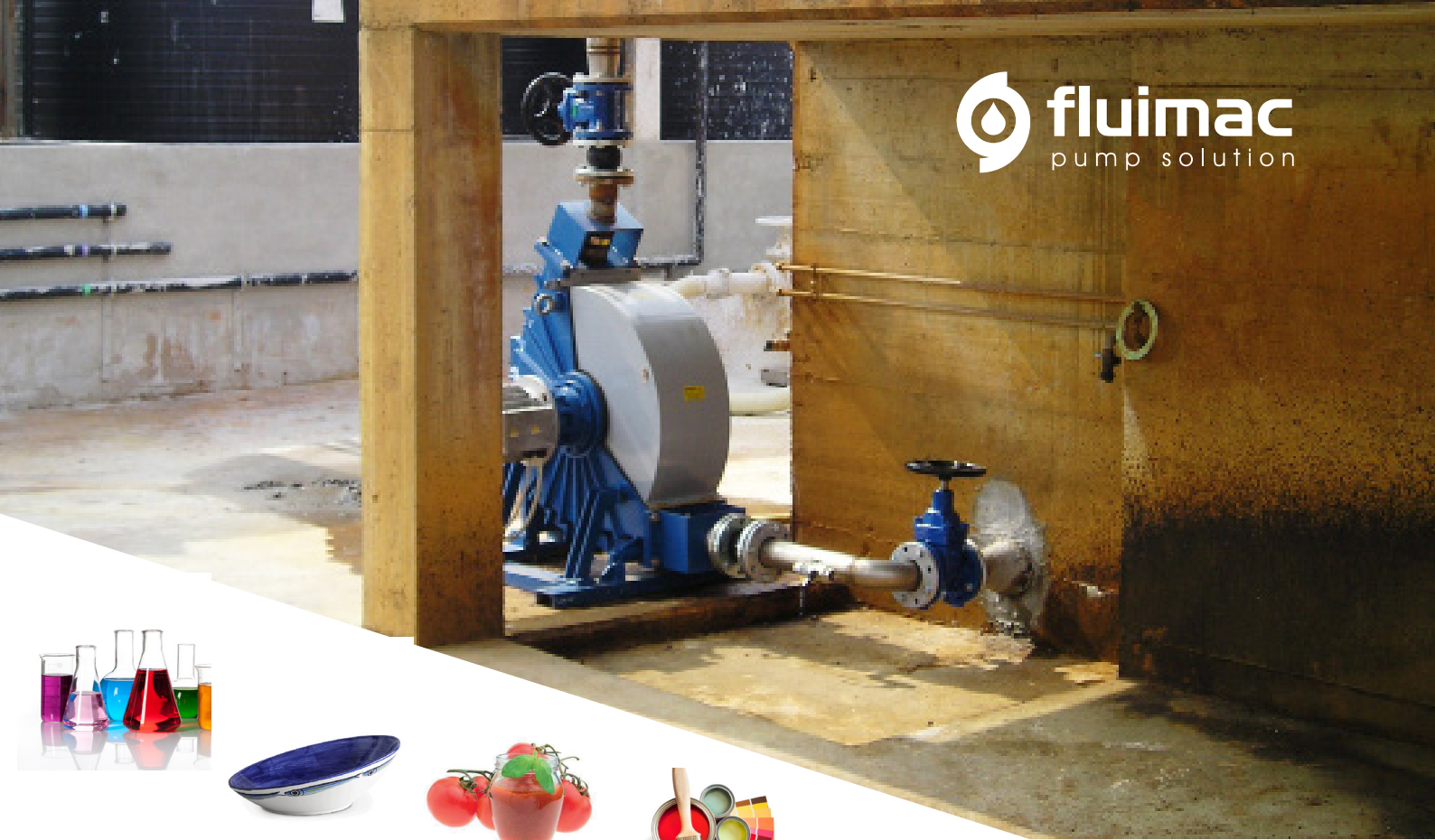

HELIOS ATR

Pompe peristaltiche

Portata max: 64000 l/min - prevalenza max: 8 bar
 Viscosità fino a 60000 cps - aspirazione fino a 8 m

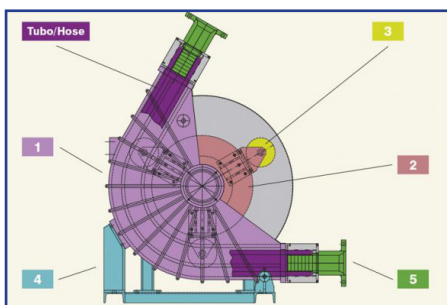

Elemento

- 1 Corpo pompa
- 2 Rotore
- 3 Rulli
- 4 Basamento
- 5 Flange ISO

Materiale

- Ghisa
- Ferro
- Nylatron di alluminio
- Ferro
- AISI 304

Abbinamenti speciali:

- DIN
- TRI-CLAMP
- ANSI, ISO, UNI, CON FLANGE

CARATTERISTICHE TECNICHE

- Nessuna chiusura meccanica o premistoppa
- Resistente
- Adatta per fluidi viscosi e aggressivi
- Aspirazione a secco continua e priva di danni
- Pressione di uscita fino a 8 bar
- Manutenzione molto facile
- Grande performance

MATERIALI PER TUBO

- NR
- NBR
- EPDM
- NR Food
- Hypalon

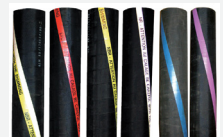

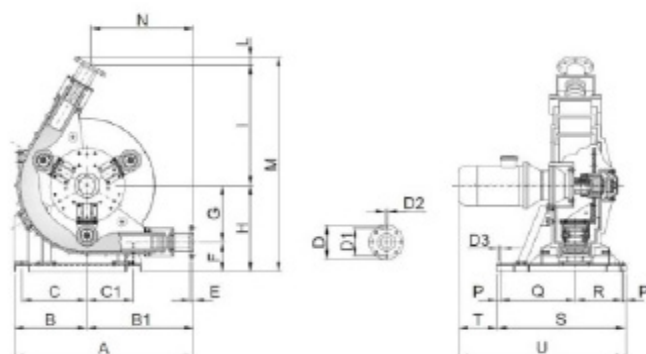

ATR 80 FX/TD

DIMENSIONI DI INGOMBRO

A	B	B1	C	C1	D	D1	D2	D3	E	F	G	H	I	L	M	N	O	P	Q	R	S	T	U
1148	467	681	417	295	220	180	16	18	22	189	365	554	772	55	1391	657	O	20	480	300	820	245	1065

DATI TECNICI

Q(L/H)	A	P	RPM	Kw	di	Qu	Nm	Kg
12160	8	50 (80)	22,3	5,5 (7,5)				
18874	8	30 (50)	34,6	5,5 (9)	80	9,1	1200	390
21915	8	25 (45)	40,1	5,5 (9)				
26422	8	20 (40)	48,4	7,5 (11)				

ATR 280 FX/TD

DIMENSIONI DI INGOMBRO

A	B	B1	C	C1	D	D1	D2	D3	E	F	G	H	I	L	M	N	O	P	Q	R	S	T	U
1148	467	681	417	295	220	180	16	18	22	189	365	554	772	55	1391	657	119	20	550	370	960	294	1254

DATI TECNICI

Q(L/H)	A	P	RPM	Kw	di	Qu	Nm	Kg
24321	8	50 (80)	22,2	7,5 (11)				
37748	8	30 (50)	34,6	11 (15)	80	18,2	2000	515
43830	8	25 (45)	40,1	11 (15)				
52845	8	20 (40)	48,4	11 (15)				

MOTORE 3 PH- VOLTS 230/400 HZ 50 R.P.M. I400 IP55

* = Dipende dal materiale del tubo
 A = Capacità di aspirazione in metri
 P = Prevalenza in metri

di = Diametro interno tubo
 Qu = Litri per giro
 Nm = Coppia minima di spunto

Ex DISPONIBILE CON CERTIFICAZIONE ATEX:
 EX: I M2 & II 2G & IIB, TX

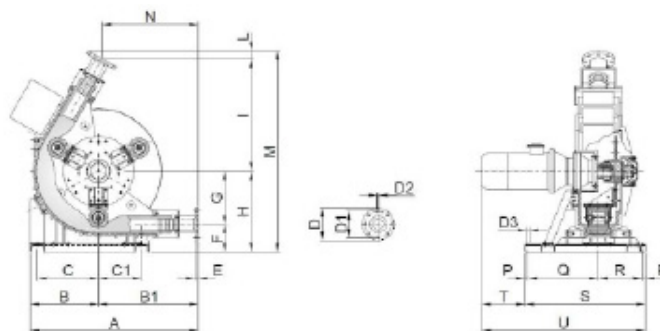

ATR 80 IX/TD

DIMENSIONI DI INGOMBRO

A	B	B1	C	C1	D	D1	D2	D3	E	F	G	H	I	L	M	N	O	P	Q	R	S	T	U
1148	467	681	417	295	220	180	16	18	22	189	365	554	772	55	1381	657	O	20	480	300	820	245	1065

DATI TECNICI

Q(L/H)	A	P	RPM	Kw	hz	di	Qu	Nm	Kg
2432 ÷ 14592	8	50 (80)	4,5 ÷ 26,7	5,5 (7,5)					
3775 ÷ 22649	8	30 (50)	6,9 ÷ 41,5	5,5 (9)	10 ÷ 60	80	9,1	1200	440
4383 ÷ 26298	8	25 (45)	8,0 ÷ 48,2	7,5 (11)					
5284 ÷ 31707	8	20 (40)	9,7 ÷ 58,1	7,5 (11)					

ATR 280 IX/TD

DIMENSIONI DI INGOMBRO

A	B	B1	C	C1	D	D1	D2	D3	E	F	G	H	I	L	M	N	O	P	Q	R	S	T	U
1148	467	681	417	295	220	180	16	18	22	189	365	554	772	55	1381	657	119	20	550	370	960	294	1254

DATI TECNICI

Q(L/H)	A	P	RPM	Kw	hz	di	Qu	Nm	Kg
4864 ÷ 29185	8	50 (80)	4,5 ÷ 26,7	11 (15)					
7550 ÷ 45298	8	30 (50)	6,9 ÷ 41,5	11 (15)	10 ÷ 60	80	18,2	2000	580
8766 ÷ 52596	8	25 (45)	8,0 ÷ 48,2	11 (15)					
10569 ÷ 63414	8	20 (40)	9,7 ÷ 58,1	11 (15)					

MOTORE 3 PH- VOLTS 230/400 HZ 50 R.P.M. I400 IP55

SEGNALE 4-20mA SU RICHIESTA

* = Dipende dal materiale del tubo
 A = Capacità di aspirazione in metri
 P = Prevalenza in metri

di = Diametro interno tubo
 Qu = Litri per giro
 Nm = Coppia minima di spunto

CURVE DI PERFORMANCE

VERSIONI SPECIALI

Portata / Output

ATR 80

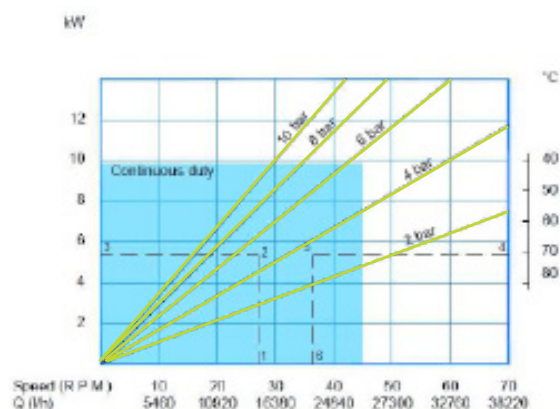

ATR 80/280 TC
TRASMISSIONE CINGHIA

Portata / Output

ATR 280

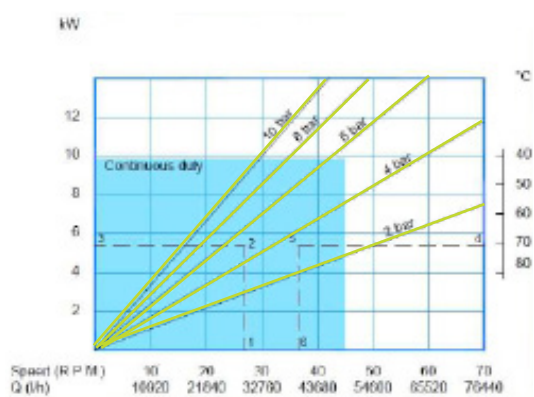

TESTA POMPANTE

COME UTILIZZARE LE CURVE

- La portata richiesta indica la velocità della pompa
- Prevalenza calcolata
- Velocità netta richiesta della potenza del motore
- Temperatura del fluido
- Velocità massima della pompa consigliata

I dati tecnici sopra indicati si riferiscono a fluidi come l'acqua e simili



TROLLEY

fluimac[®]

pump solution



FLUIMAC S.r.l.

Via Brescia 1
21049, Tradate (VA) - Italia
Tel.:+39 0331 866688
Fax:+39 0331 864870

www.fluimac.com
info@fluimac.com

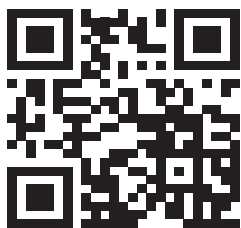

PARTNER AUTORIZZATO:

*Made in
Italy*

